

HEADER PIN

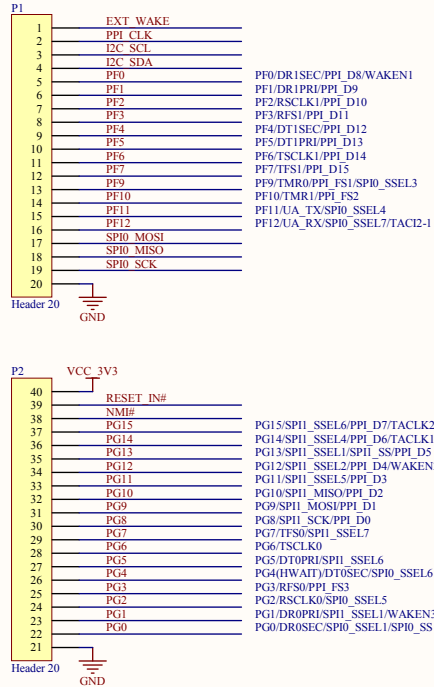

BF592

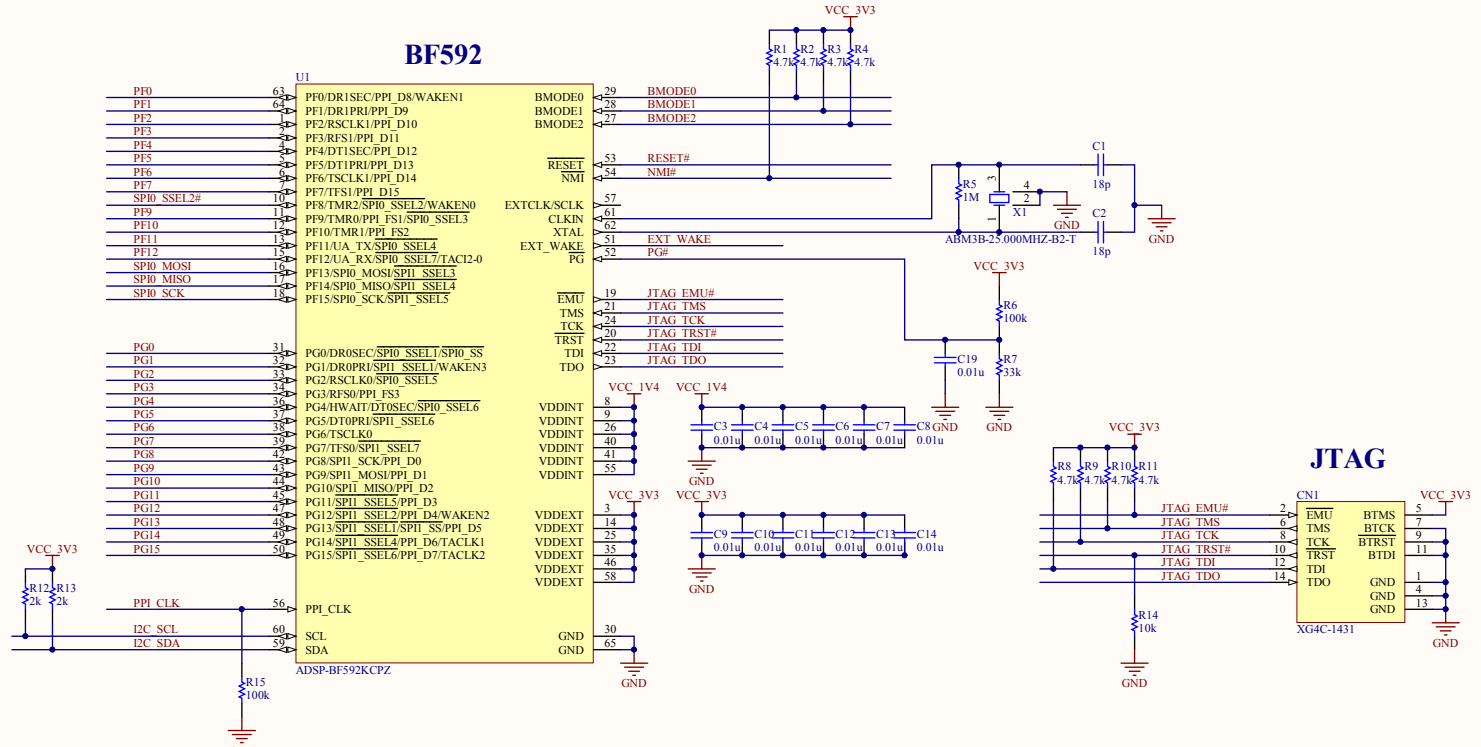

RESET SUPERVISOR

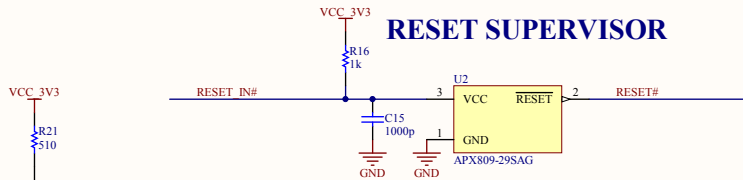

1.375V REGRATOR

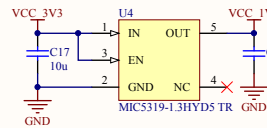

SPI FLASH

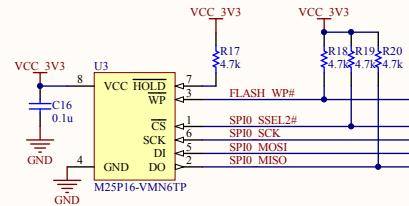

DIP Switch

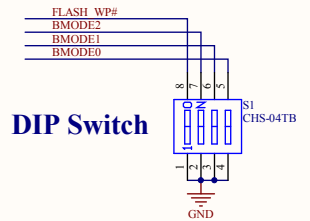

Power LED

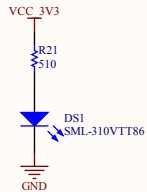

No.	年月日 DATE	訂正記事 REVISION	担当 SIGN	設計 DESIGNED	開発型式名 MODEL
1				金子	ACB-BF592-A
2				検 閲 CHECKED	名称 NAME
金子システム株式会社				印刷日時 PRINT 2012/05/28	ACB-BF592
					ACB-BF592-A-01
					1
					Sheet of 1